

Figuren legen

mit 6 Dreiecken

Name: _____

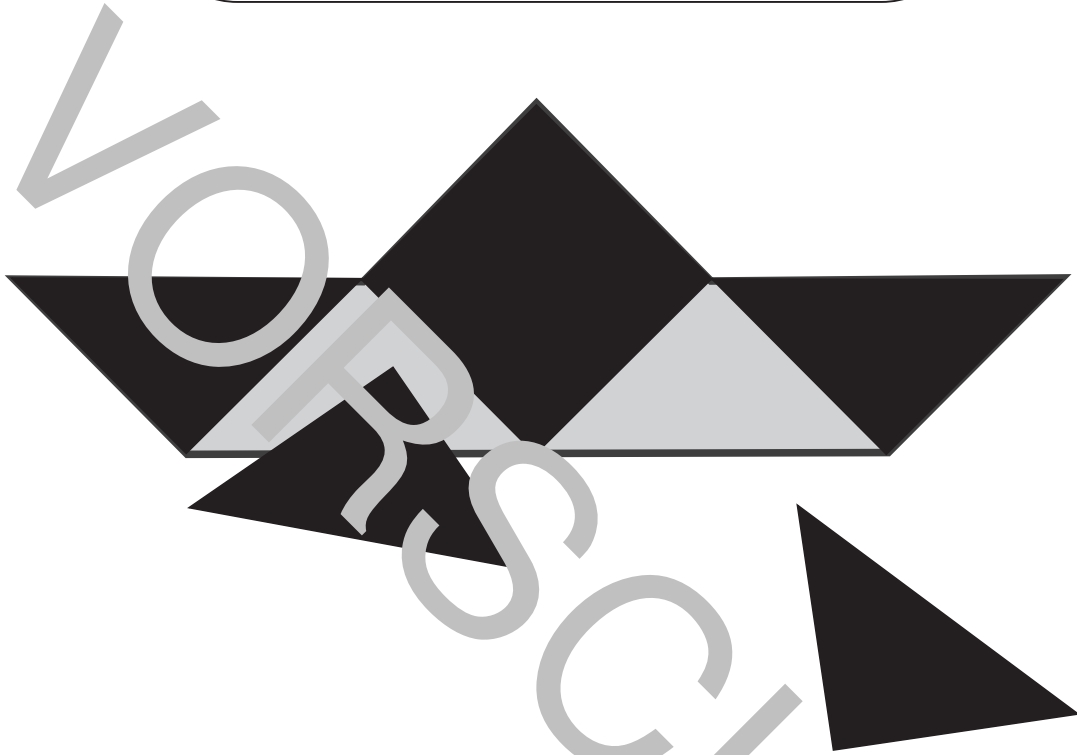

Figuren legen

mit 6 Dreiecken

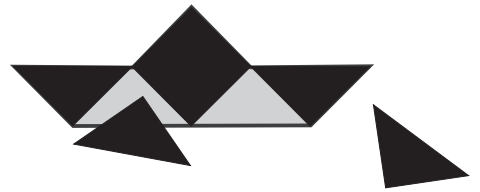

Aufgabenübersicht:

Nr.1	Nr.2	Nr.3	Nr.4
Nr.5	Nr.6	Nr.7	Nr.8
Nr.9	Nr.10	Nr.11	Nr.12
Nr.13	Nr.14	Nr.15	Nr.16
Nr.17	Nr.18	Nr.19	Nr.20
Nr.21	Nr.22	Nr.23	Nr.24



Name:

Datum:

Figuren legen 1

Schneide die Teile aus und lege die Figur nach.



Figuren legen mit 6 Dreiecken
© Geraldine Kalberla

www.lern-kiste.de

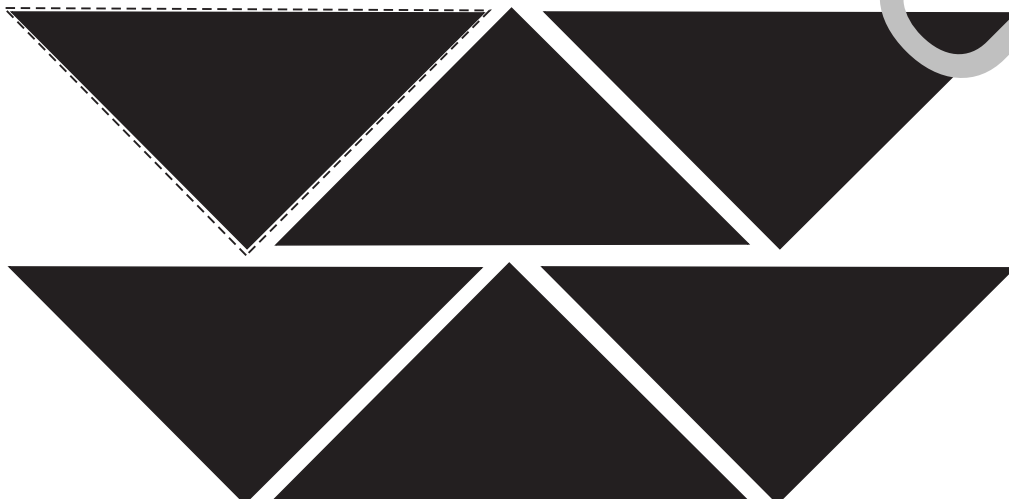

Name:

Datum:

Figuren legen 2

Schneide die Teile aus und lege die Figur nach.

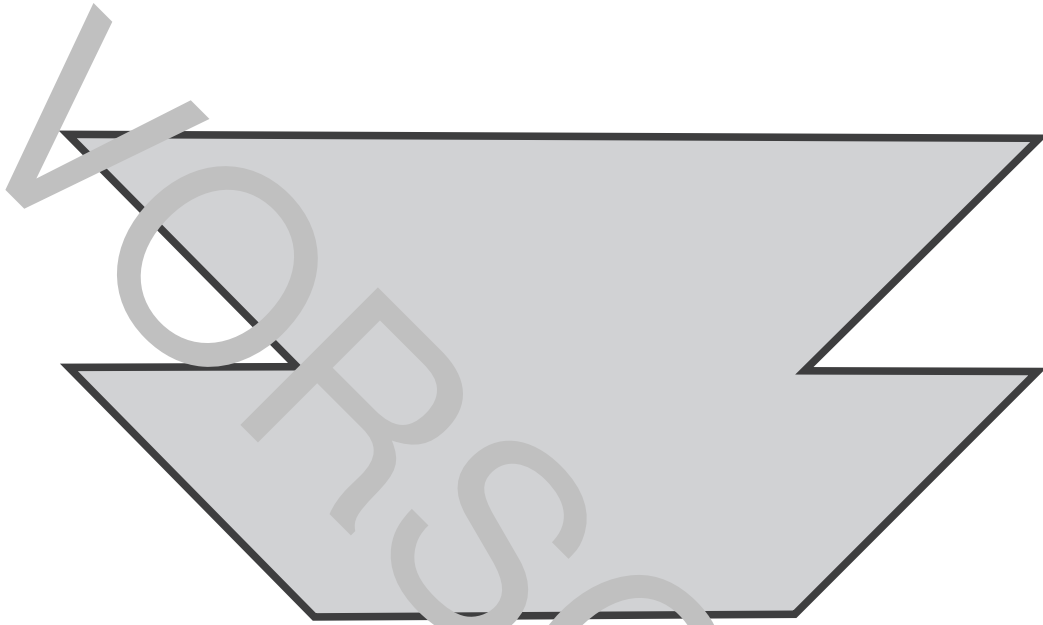

Figuren legen mit 6 Dreiecken
© Geraldine Kalberla

www.lern-kiste.de



Name:

Datum:

Figuren legen 9

Schneide die Teile aus und lege die Figur nach.

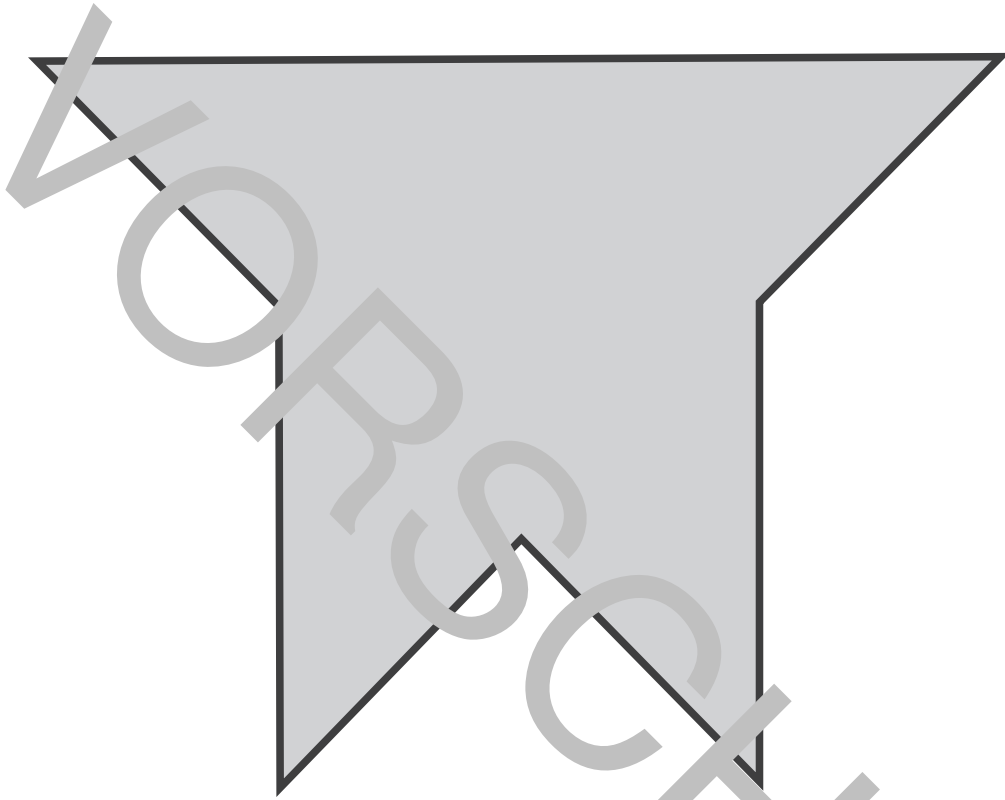

Figuren legen mit 6 Dreiecken
© Geraldine Kalberla

www.lern-kiste.de

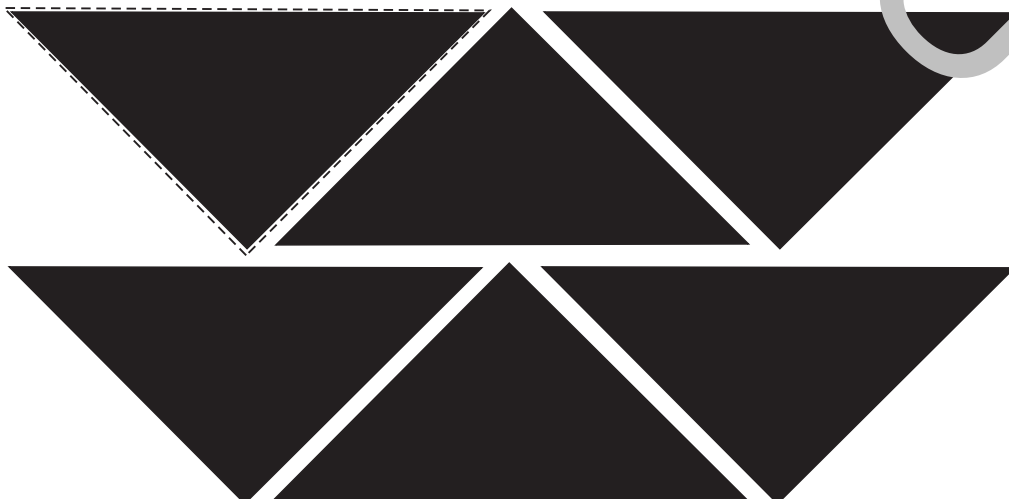

Name:

Datum:

Figuren legen 10

Schneide die Teile aus und lege die Figur nach.

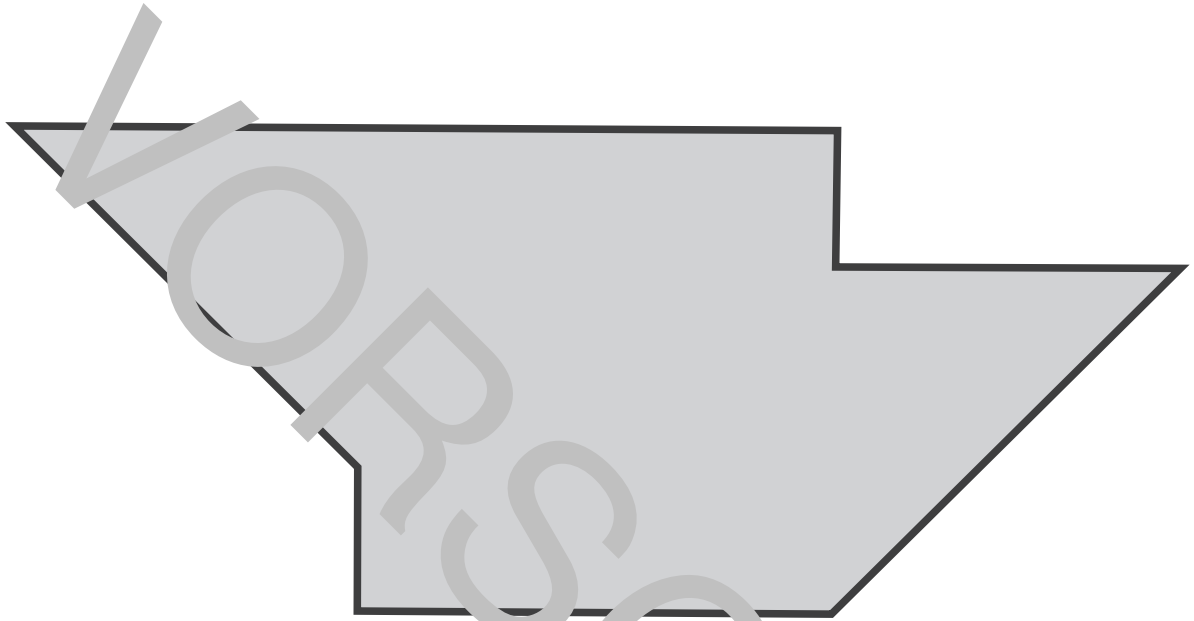

Figuren legen mit 6 Dreiecken
© Geraldine Kalberla

www.lern-kiste.de

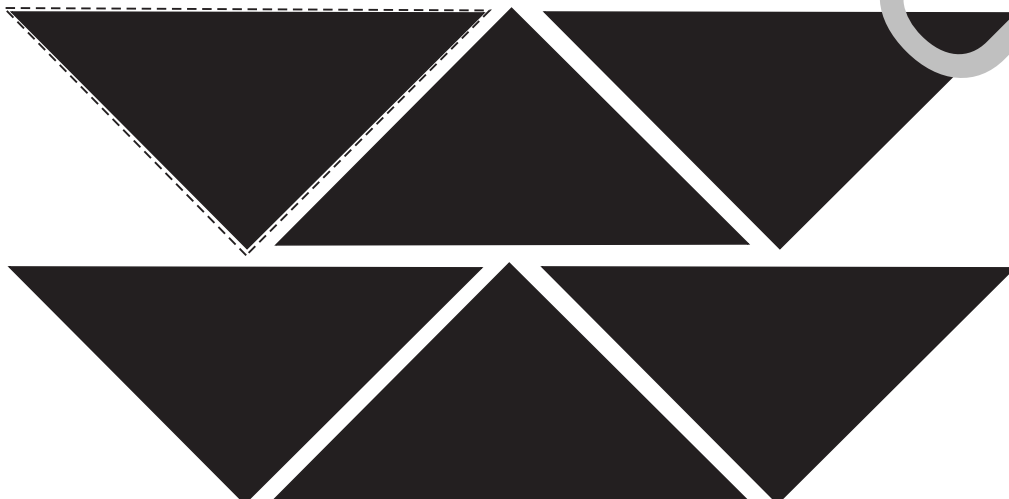

Name:

Datum:

Figuren legen 13

Schneide die Teile aus und lege die Figur nach.

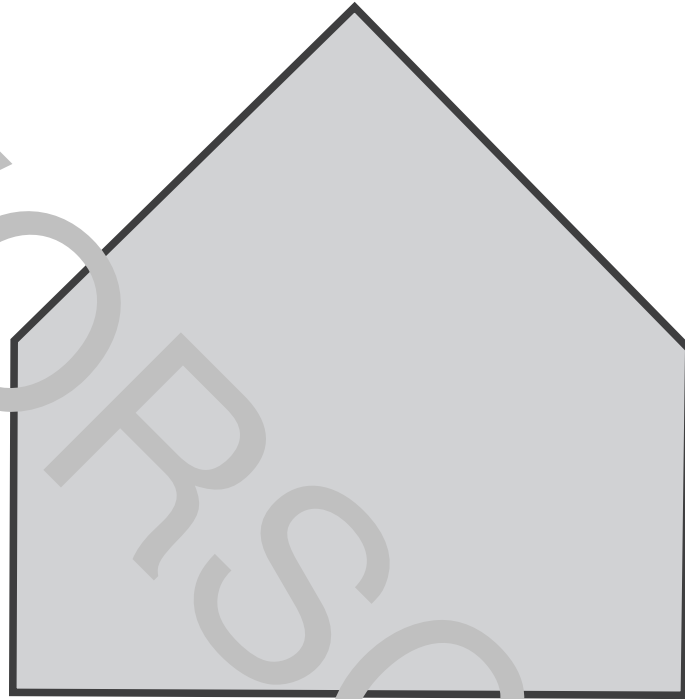

Figuren legen mit 6 Dreiecken
© Geraldine Kalberla

www.lern-kiste.de

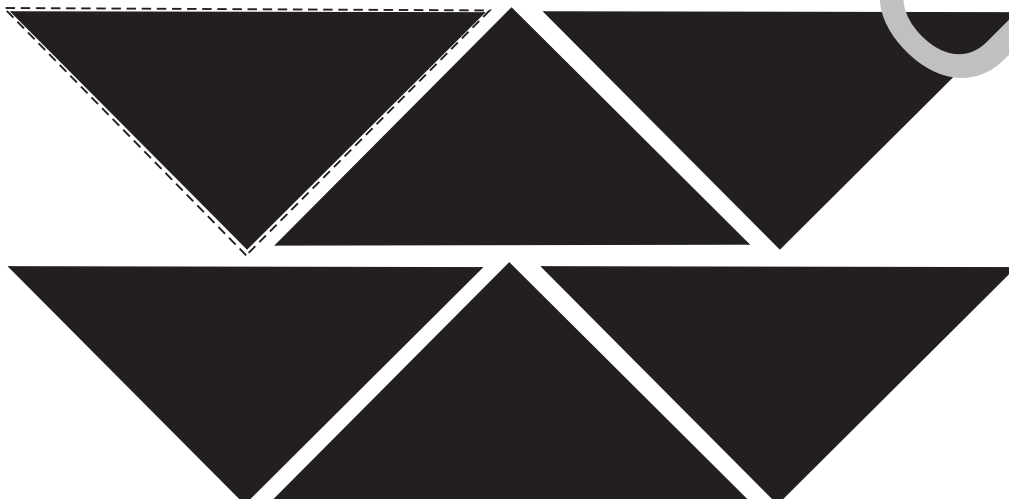

Name:

Datum:

Figuren legen 14

Schneide die Teile aus und lege die Figur nach.

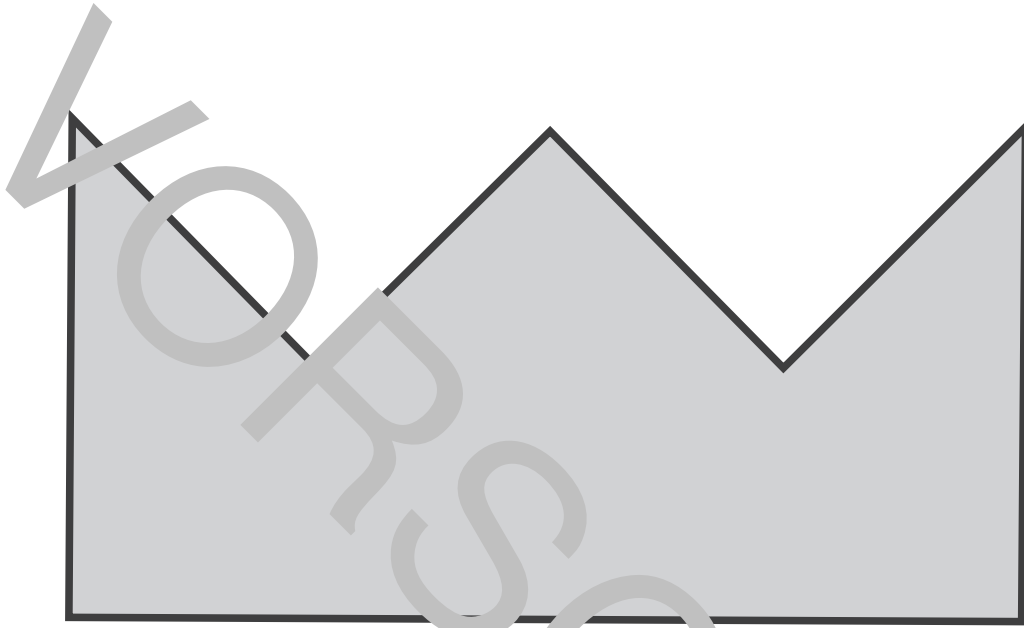

Figuren legen mit 6 Dreiecken
© Geraldine Kalberla

www.lern-kiste.de



Lösung: Figuren legen 1

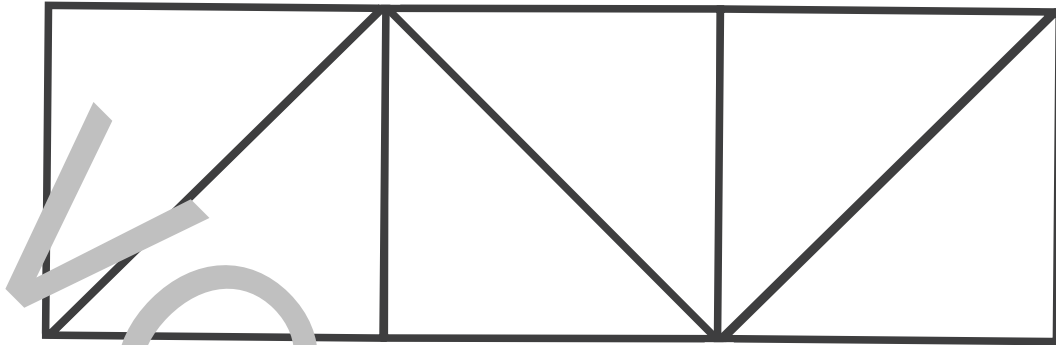

Figuren legen mit 6 Dreiecken
© Geraldine Kalberta

www.lern-kiste.de

Lösung: Figuren legen 2

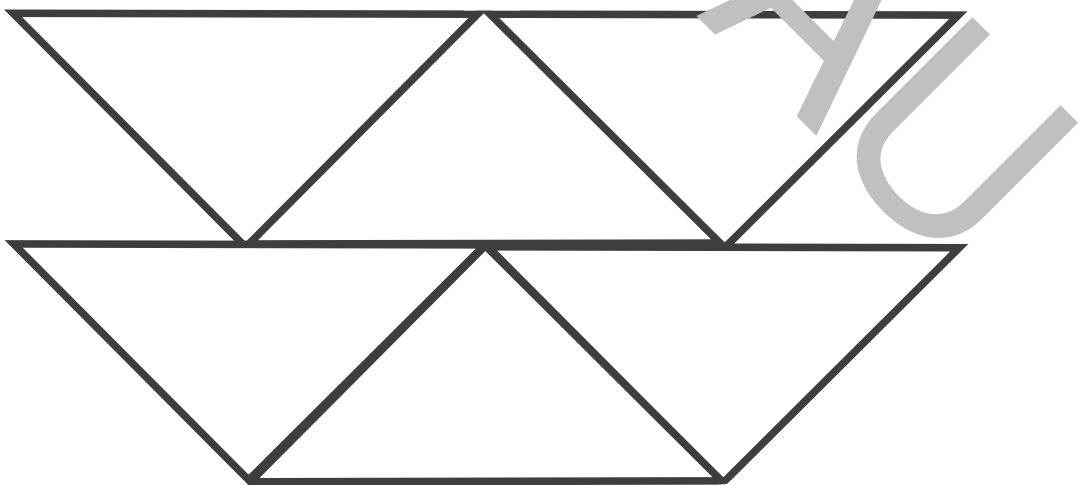

Figuren legen mit 6 Dreiecken
© Geraldine Kalberta

www.lern-kiste.de

Lösung: Figuren legen 9

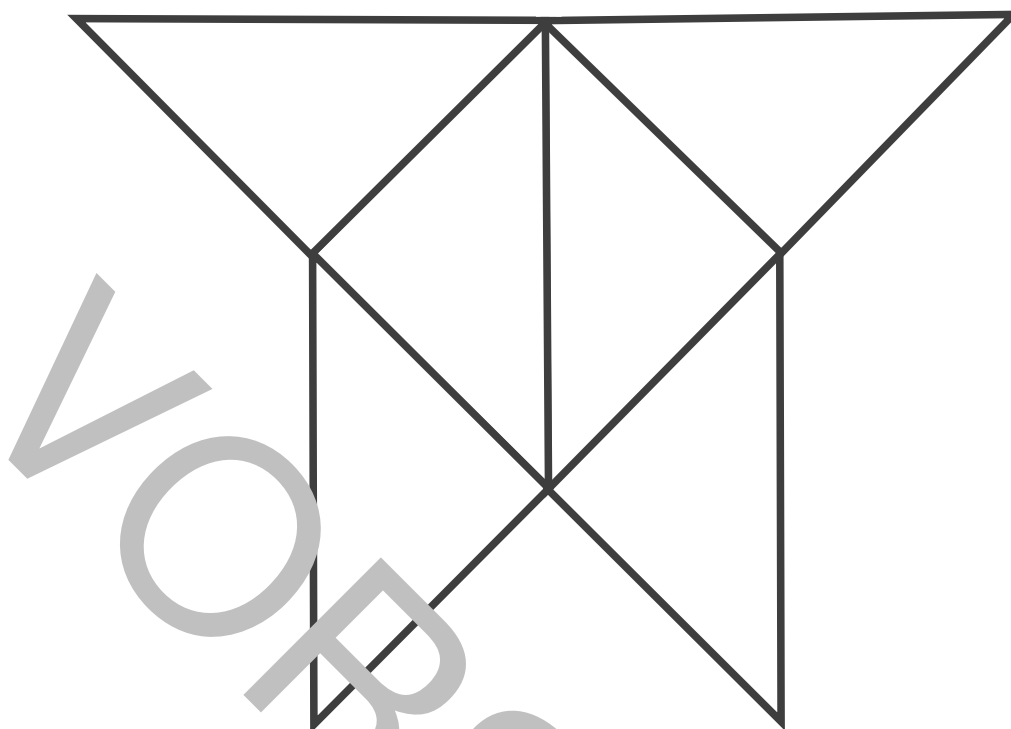

Figuren legen mit 6 Dreiecken
© Geraldine Kalberta

www.lern-kiste.de

Lösung: Figuren legen 10

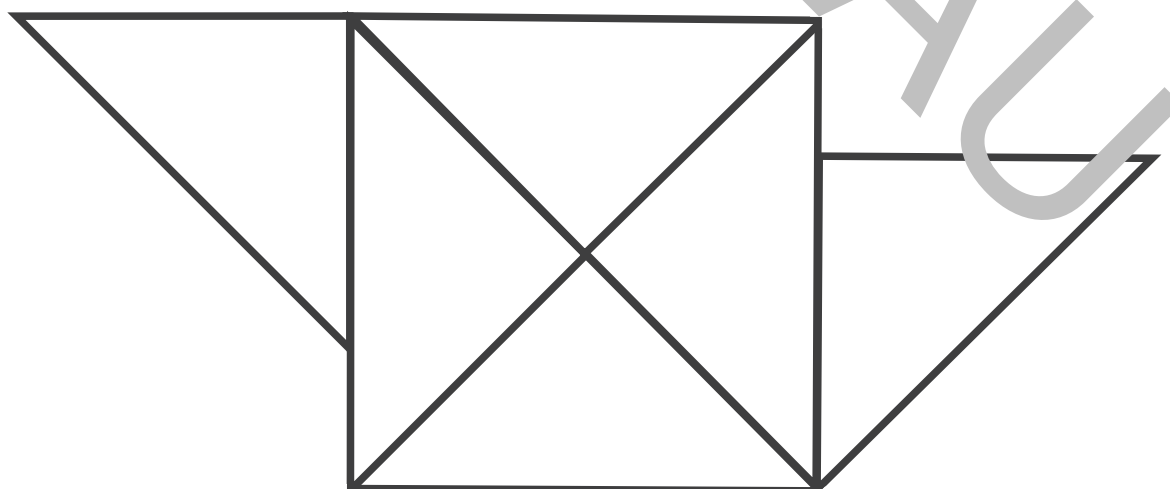

Figuren legen mit 6 Dreiecken
© Geraldine Kalberta

www.lern-kiste.de

Lösung: Figuren legen 13

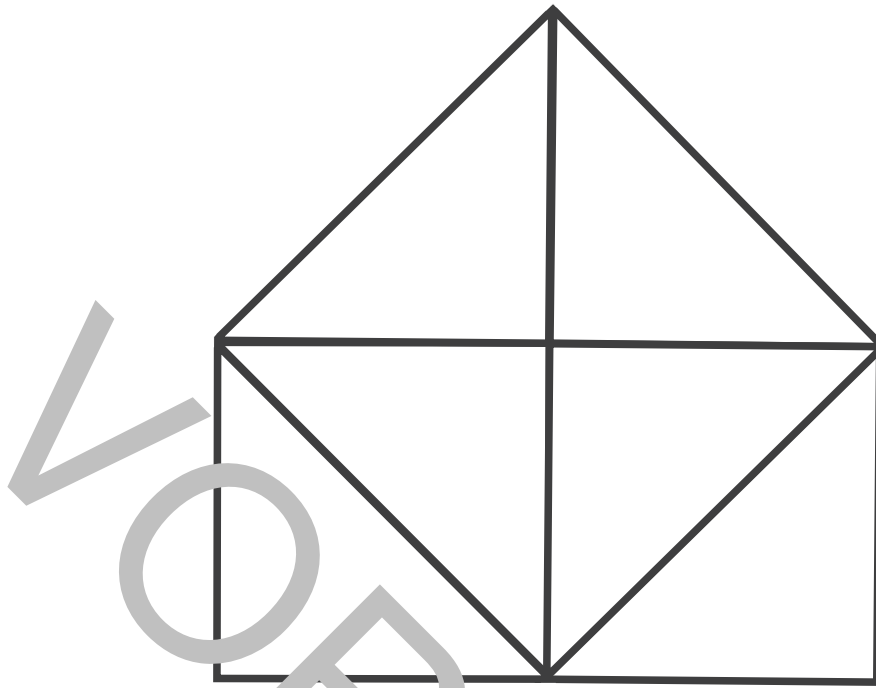

Figuren legen mit 6 Dreiecken
© Geraldine Kalberta

www.lern-kiste.de

Lösung: Figuren legen 14

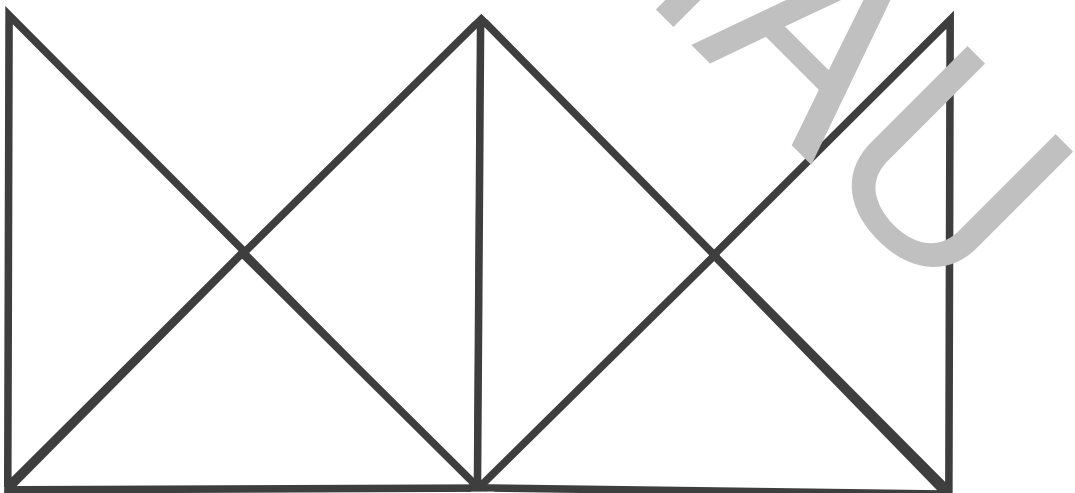

Figuren legen mit 6 Dreiecken
© Geraldine Kalberta

www.lern-kiste.de